

# Cobb

CERAMICHE  
SUPERGRES

Non c'è un solo particolare in quel paesaggio che non mi ricordi il tempo felice della mia infanzia: le foglie, gli alberi, perfino i piccoli sassi sulla riva del torrente riecheggiano nella mia memoria le risate, i colori e il profumo dei giorni passati.

Nelle strade ghiaiate in collina, ormai abbandonate, rivedo mio padre che mi insegna ad andare in bicicletta.

Porto ancora in tasca alcuni di quei piccoli ciottoli che mi hanno visto cadere e rialzare.

# Cobb

CERAMICHE  
SUPERGRES



# Cobb

There is not a single detail in that landscape that does not remind me of the happy times of my childhood: the leaves, the trees, even the small pebbles on the bank of the stream echo in my memory the laughter, the colours and the scent of days gone by. On the gravel roads in the hills, now abandoned, I see my father teaching me how to ride a bicycle. I still carry in my pocket some of those little pebbles that saw me fall and get up again

Le moindre détail de ce paysage me rappelle le temps heureux de mon enfance : les feuilles, les arbres, jusqu'aux petits cailloux sur la berge du torrent font résonner dans ma mémoire les rires, les couleurs et le parfum des temps passés. Sur les routes de gravier qui sillonnent la colline, désormais abandonnées, je revois mon père qui m'apprend à faire du vélo. J'ai encore dans les poches quelques petits galets qui m'avaient vu tomber et me relever.

Kein einziges Detail in dieser Landschaft, erinnert mich nicht an meine glückliche Kindheit: Blätter, Bäume, selbst kleine Steine am Ufer des Baches rufen in meiner Erinnerung das Lachen, die Farben und den Duft vergangener Tage wach. Auf den Schotterstraßen in den jetzt verlassenem Hügel, sehe ich meinen Vater, wie er mir das Fahrradfahren beibringt. Ich trage immer noch einige dieser kleinen Kieselsteine in meiner Tasche, die mich fallen und wieder aufstehen ließen.



SAND

GREY

LIGHT

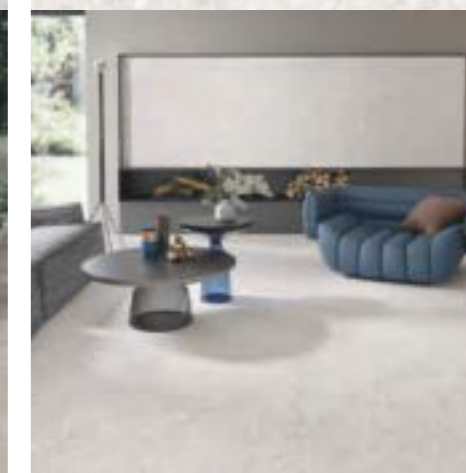
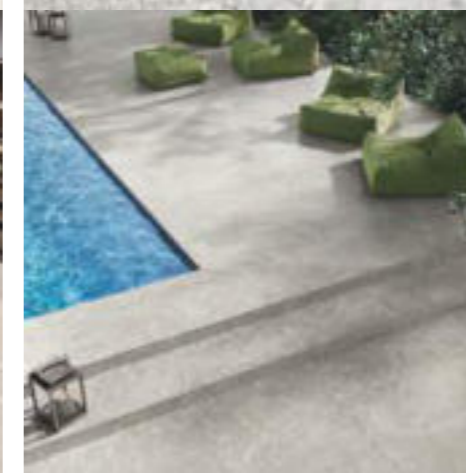
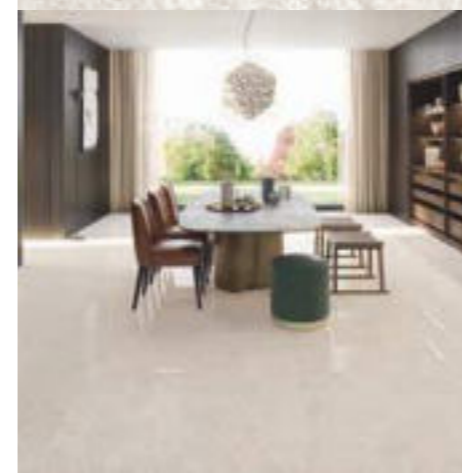
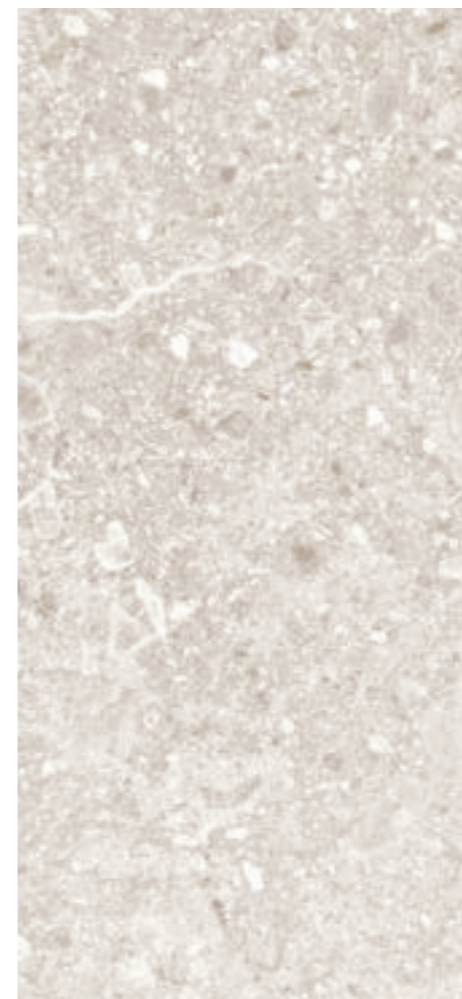

COLORI COLOURS



SAND

GREY

LIGHT

FORMATI SIZES

6 mm | 120x278 RT



120x278 RT



GREY



120x120 RT



60x120 RT

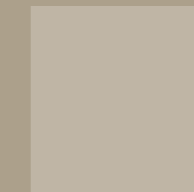

60x60 RT



30x60 RT

9 mm | Anti slip soft Touch R10 B | 120x120 RT | 60x120 RT | 60x60 RT | 30x60 RT

9 mm | Lux | 120x120 RT | 60x120 RT

9 mm | Grip R11 C su richiesta



SAND



GREY



LIGHT



60x120 RT



60x60 RT

20 mm | T20 R11 C 60x120 RT | 60x60 RT



SAND



GREY



LIGHT

5

# Cobb

Gres Porcellanato . Porcelain stoneware  
Grès cérame . Feinsteinzeug

# Cobb

SAND

Memorie d'infanzia.

COBB SAND



Cobb Sand 120x120 RT . 48"x48"





# Cobb

## SAND

Nuance moderne, delicate vibrazioni cromatiche per rivestire in spazi interni ed esterni ogni tipologia di ambiente. Una superficie dinamica, ricca di dettagli naturali, apporta unicità e spazi dallo stile elegante.

Modern nuances, delicate colour vibrations to cover every architectural need in indoor and outdoor spaces. A dynamic surface, rich in natural details, gives personality to essentially-styled spaces.

Des nuances modernes, de délicates vibrations chromatiques pour revêtir toutes les exigences architecturales des espaces intérieurs et extérieurs. Une surface dynamique, riche de détails naturels, apporte un caractère unique et des espaces au style élégant.

Kein einziges Detail in dieser Landschaft, erinnert mich nicht an meine glückliche Kindheit: Blätter, Bäume, selbst kleine Steine am Ufer des Baches rufen in meiner Erinnerung das Lachen, die Farben und den Duft vergangener Tage wach. Auf den Schotterstraßen in den jetzt verlassenen Hügeln, sehe ich meinen Vater, wie er mir das Fahrradfahren beibringt. Ich trage immer noch einige dieser kleinen Kieselsteine in meiner Tasche, die mich fallen und wieder aufstehen lassen.





Cobb Sand LUX 60x120 RT . 24"x48"



# Cobb

SAND



Cobb Sand LUX 60x120 RT . 24"x48"

# Cobb

GREY

Viaggio in Europa

COBB GREY



Cobb Grey 120x120 RT . 48"x48"  
Cobb Grey 120x278 RT . 48"x109 1/2"  
Cobb Grey linear 29.5x120 RT 12"x48"



Cobb Grey 120x120 RT . 48"x48" Cobb Grey 120x278 RT . 48"x109 1/2" Cobb Grey linear 29.5x120 RT 12"x48"



# Cobb

GREY

Superficie materica ma morbida al tatto, venature calde dai toni naturali, rivestono con eleganza contemporanea pareti e pavimenti.

Textured but soft-to-touch surface, soft veining in natural tones cover walls and floors with contemporary elegance.

Les surfaces effet matière et lisses au toucher, les veines chaudes aux tons naturels ornent avec une élégance contemporaine les murs et les sols.

Stofflichkeit mit weichem Griff, warme Maserungen in Naturtönen verkleiden Wände und Böden mit moderner Eleganz.

Cobb Grey 120x120 RT . 48"x48"  
Cobb Grey 120x278 RT . 48"x109 1/2"  
Cobb Grey linear 29.5x120 RT 12"x48"

# Cobb

GREY



Cobb Grey 120x120 RT . 48"48"  
Cobb Grey 120x278 RT . 48"x109 1/2"  
Cobb Grey Idro 50.3x58 . 20"x23"



Cobb Grey 120x120 RT . 48"48"  
Cobb Grey 120x278 RT . 48"x109 1/2"  
Cobb Grey Idro 50.3x58 . 20"x23"







# Cobb

GREY T20



Cobb Grey T20 60x120 RT . 24"x48"

# Cobb

LIGHT

Racconto di un'estate

COBB LIGHT



Cobb Light LUX 120x120 RT . 48"x48"



Cobb Light LUX 120x120 RT . 48"x48"





# Cobb

## LIGHT

Spazi aperti e chiari dove la luce naturale accarezza gli ambienti sottolineandone l'ordine e la pulizia, scaldandone il rigore delle forme, in quell'atmosfera di tranquillità carica di attese che preannuncia il risveglio.

Open and bright spaces where natural light caresses the rooms emphasising their order and cleanliness, warming the rigour of their forms, in that calm atmosphere full of expectation that announces the awakening

Des espaces ouverts et lumineux, où la lumière naturelle caresse les espaces en soulignant leur ordre et leur propreté, réchauffant la rigueur des formes, dans cette atmosphère de tranquillité pleine des attentes qui annoncent le réveil

Offene und helle Räume, in denen das natürliche Licht die Räume aufhellt und ihre Ordnung und Sauberkeit unterstreicht, die Strenge ihrer Formen wärmt, in jener Atmosphäre der Ruhe und Erwartung, die das Erwachen ankündigt

Cobb Light 120x120 RT . 48"x48"

Cobb Light Linear 29.5x120 RT . 12"x48"

41



Cobb Light 120x120 RT . 48"x48"

Cobb Light Linear 29.5x120 RT . 12"x48"

# Cobb

LIGHT







Cobb Light T20 60x120 RT . 24"x48"



# Cobb

LIGHT

# Cobb

Gres Porcellanato  
Porcelain stoneware | Grès cérame | Feinsteinzeug

## SAND

9 mm  | Anti slip soft Touch (ASST) R10 B | 120x120 RT | 60x120 RT | 60x60 RT | 30x60 RT

9 mm  | Lux | 120x120 RT | 60x120 RT

9 mm  | Grip R11 C | 120x120 RT | 60x120 RT | 60x60 RT | 30x60 RT \*

\*disponibile su richiesta -available only upon request

# Cobb

Gres Porcellanato  
Porcelain stoneware | Grès cérame | Feinsteinzeug

## GREY

9 mm  | Anti slip soft Touch (ASST) R10 B | 120x120 RT | 60x120 RT | 60x60 RT | 30x60 RT

9 mm  | Lux | 120x120 RT | 60x120 RT

9 mm  | Grip R11 C | 120x120 RT | 60x120 RT | 60x60 RT | 30x60 RT \*

6 mm  | 120x278 RT

\*disponibile su richiesta -available only upon request



120x120 RT  
48"x48"

60x120 RT  
24"x48"

60x60 RT  
24"x24"

30x60 RT  
12"x24"



120x120 RT  
48"x48"

120x278 RT  
48"x109 1/2"

60x120 RT  
24"x48"

60x60 RT  
24"x24"

30x60 RT  
12"x24"

# Cobb

Gres Porcellanato  
Porcelain stoneware | Grès cérame | Feinsteinzeug

## LIGHT

9 mm  | Anti slip soft Touch (ASST) R10 B | 120x120 RT | 60x120 RT | 60x60 RT | 30x60 RT

9 mm  | Lux | 120x120 RT | 60x120 RT

9 mm  | Grip R11 C 120x120 RT | 60x120 RT | 60x60 RT | 30x60 RT \*

\*disponibile su richiesta -available only upon request

# Cobb

Gres Porcellanato  
Porcelain stoneware | Grès cérame | Feinsteinzeug

## T\_20

20 mm  | T20 R11 C 60x120 RT | 60x60 RT

### SAND



T\_20 60x120 RT  
24"x48"

### GREY



T\_20 60x120 RT  
24"x48"

### LIGHT

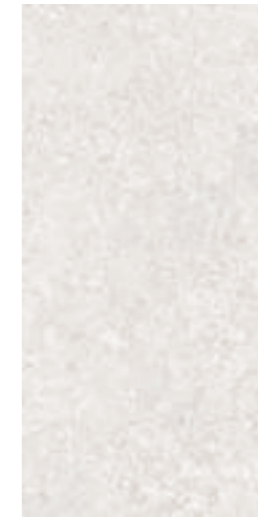

T\_20 60x120 RT  
24"x48"

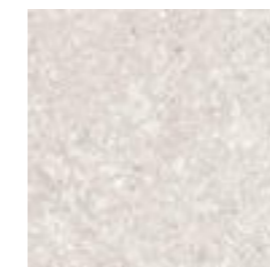

T\_20 60x60 RT  
24"x24"



T\_20 60x60 RT  
24"x24"

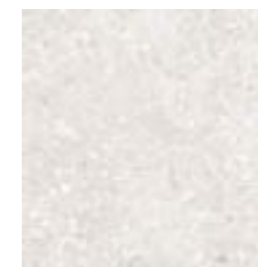

T\_20 60x60 RT  
24"x24"



120x120 RT  
48"x48"

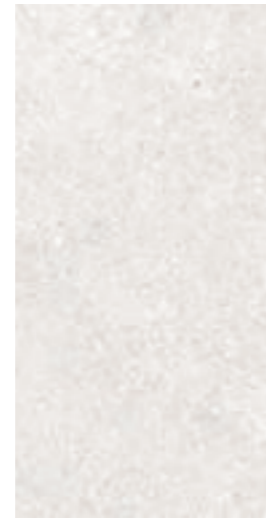

60x120 RT  
24"x48"

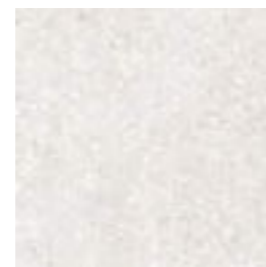

60x60 RT  
24"x24"



30x60 RT  
12"x24"

## MOSAICO IDRO



Cobb Sand Idro  
50.3x58 . 20"x23"



Cobb Grey Idro  
50.3x58 . 20"x23"



Cobb Light Idro  
50.3x58 . 20"x23"



Cobb Grey Idro 50.3x58 . 20"x23"

## MOSAICO



Cobb Sand Mosaico  
30x30 RT . 12"x12"



Cobb Grey Mosaico  
30x30 RT . 12"x12"



Cobb Light Mosaico  
30x30 RT . 12"x12"

## MURETTO LINEAR



Cobb Sand Linear  
29.5x120 RT . 12"x48"



Cobb Grey Linear  
29.5x120 RT . 12"x48"



Cobb Light Linear  
29.5x120 RT . 12"x48"

## PEZZI SPECIALI | SPECIAL TILES | PIÈCES SPÉCIALES | FORMTEILE

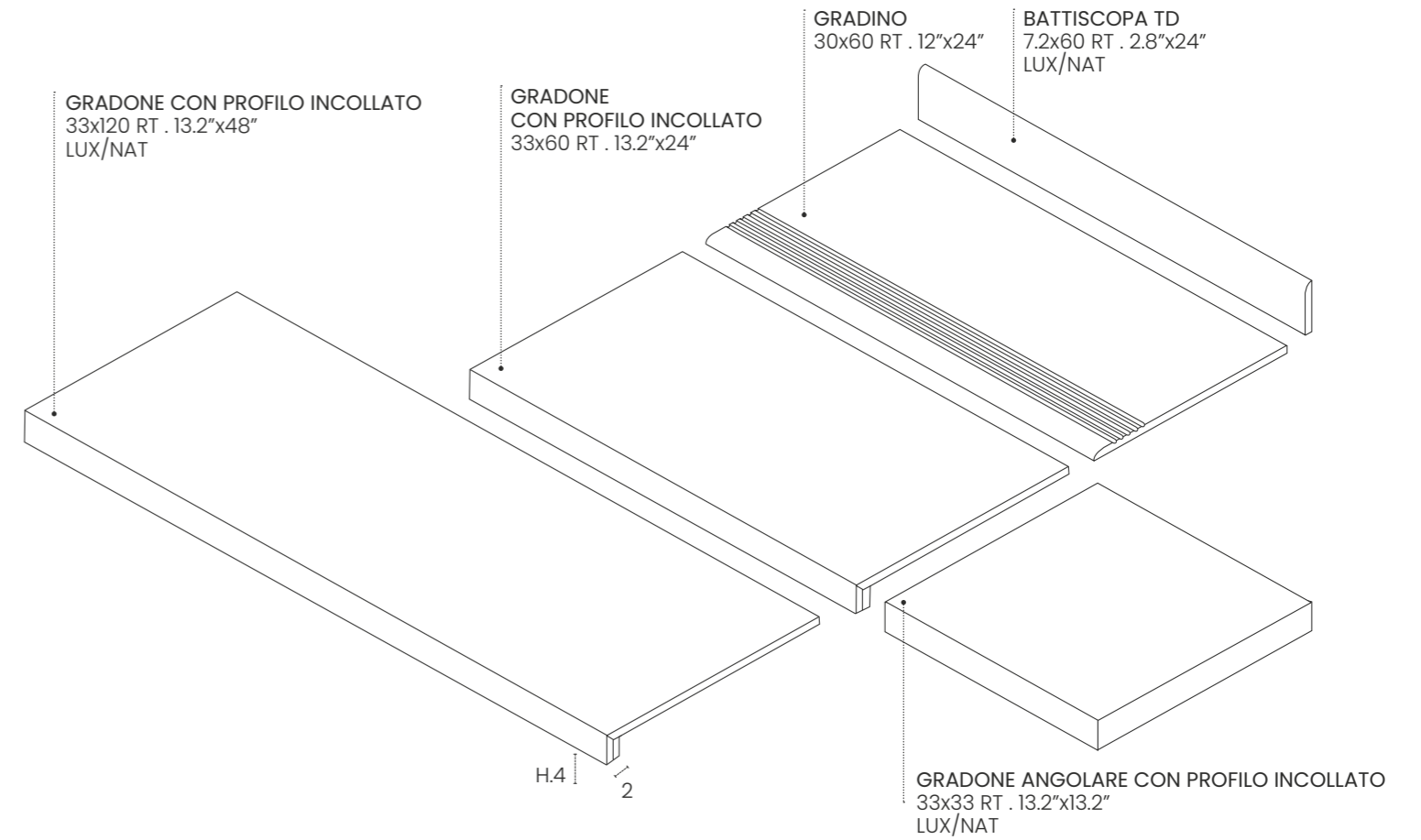

PEZZI SPECIALI DISPONIBILI SU TUTTI I COLORI, SU ORDINAZIONE.  
TRIM TILES AVAILABLE IN ALL COLORS TO ORDER.  
PIÈCES SPÉCIALES DISPONIBLES DANS TOUTES LES COULEURS, SUR DEMANDE.  
FORMTEILE AUF BESTELLUNG IN ALLEN FARBEN VERFÜGBAR.

IMBALLI | EMBALLAGE | VERPACKUNG | PACKING

	pz/box	mq/box	kg/box	box/plt	mq/plt	kg/plt	spessore
120x278RT cassa / crate cm 291,6x144,5x33,8 kg 88	1	3,34	49,50	18	60,05	979	6 mm
120x278RT cassa leggera (max 5pz) cm 291,6x144,5x24 kg 54	1	3,34	49,50	5	16,68	301	6 mm
120x278RT cavalletto / stand containing (18pz) (carico max / charge max 42pz)	1	3,34	49,50	18	60,05	1051	6 mm
	pz/box	mq/box	kg/box	box/plt	mq/plt	kg/plt	spessore
120x120RT NAT / LUX / GRIP	2	2,88	60,00	20	57,60	1212	9 mm
60x120RT NAT / LUX / GRIP	2	1,44	30,00	35	50,40	1062	9 mm
60x60RT / 60x60RT GRIP	3	1,08	22,00	40	43,20	892	9 mm
30x60 RT / 30x60RT GRIP	7	1,26	25,00	40	50,40	1012	9 mm
mosaico 30x30RT	10	0,90	16,00	30	27,00	495	9 mm
Idro 50.3x58	3	0,656	13,00	-	-	-	9 mm
Linear 29.5x120	2	0,71	14,50	-	-	-	9 mm
battiscopa 7,2x60 LUX/NAT	10	6,00 ml	9,00	70	420 ml	645	-
gradone c/p inc. 33x120RT LUX/NAT	2	-	-	-	-	-	-
gradone c/p inc. 33x60RT	4	-	-	-	-	-	-
angolare gradone c/p inc. 33x33RT LUX/NAT	4	-	-	-	-	-	-
gradino 30x60RT	7	-	-	-	-	-	-
60x120 RT T20	1	0,72	32,00	35	25,20	1135	20 mm
60x60 RT T20	2	0,72	32,00	30	21,60	972	20 mm

AVVERTENZE PER LA POSA | RECOMMENDATIONS FOR INSTALLATION | RECOMMANDATIONS POUR LA POSE | VERLEGETIPPS

Per la posa del materiale rettificato si prescrive una fuga minima di 2 mm . As for rectified materials, a minimum joint of 2 mm is required . Pour la pose du matériau rectifié, il faut réaliser un joint minimum de 2 mm . Für die Verlegung des geschliffenen Materials ist eine Mindestfuge von 2 mm vorgeschrieben .

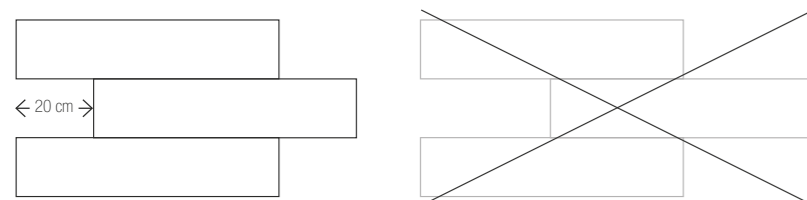

Si raccomanda di posare i materiali sfalsati di 20 cm al massimo, mai a metà della loro lunghezza . It is strongly recommended to install the materials in a staggered pattern of a maximum of 20 cm, never at half way its length . Il est conseillé de poser les matériaux en décalé de 20 cm au maximum, jamais à la moitié de leur longueur . Es wird empfohlen, die Materialien um höchstens 20 cm versetzt zu verlegen und nie in der Mitte ihrer Länge

GRUPPO BIa

Norma di riferimento: EN 14411 (ISO 13006) Allegato G - Piastrelle di ceramica pressate a secco con basso assorbimento d'acqua (Ev 0,5%)  
Norme retenue: EN 14411 (ISO 13006) Annexe G - Carreaux céramiques pressés à sec avec faible absorption d'eau (Ev ≤ 0,5%) . Besugznorm: EN 14411 (ISO 13006) Anlage G - Trockengepresste keramische Fliesen und Platten mit niedriger Wasseraufnahme (Ev ≤ 0,5%) . Reference standard: EN 14411 (ISO 13006) Appendix G - Dry pressed ceramic tiles with low water absorption (Ev ≤ 0,5%)

CARATTERISTICHE TECNICHE . TECHNICAL CHARACTERISTICS Caracteristiques techniques . Technische eigenschaften	NORMA NORMS Normes Normen	REQUISITI RICHIESTI . REQUIREMENTS Conditions requisés . Geforderte eigenschaften			VALORE MEDIO SUPERGRES * Valeur moyenne . Average rating				
		7 cm ≤ N > 15 cm	N ≥ 15 cm		SUPERFICIE NATURALE	SUPERFICIE LUX (GL)	SUPERFICIE GRIP	T20	
Lunghezza e larghezza dei lati . Lenght and width of the sides Longuer et largeur de côtés . Länge und Breite	ISO 10545-2	RETTIFICATI	± 0,4 mm	± 0,3 %	± 1,0 mm	Conforme . According to Conforme . Gemäss			
Rettilineità degli spigoli . Straightness Equerrage des angles . Kantengeradheit			± 0,4 mm	± 0,3 %	± 0,8 mm	Conforme . According to Conforme . Gemäss			
Ortogonalità** . Rectangularity** Orthogonalité . Rechtwinkligkeit			± 0,4 mm	± 0,3 %	± 1,5 mm	Conforme . According to Conforme . Gemäss			
Planarità . Flatness Planéité . Planität			± 0,6 mm	± 0,4 %	± 1,8 mm	Conforme . According to Conforme . Gemäss			
Spessore . Thickness Epaisseur . Stärke	ISO 10545-2		± 0,5 mm	± 5 %	± 0,5 mm	Conforme . According to Conforme . Gemäss			
Assorbimento % d'acqua . Water absorption Absorption d'eau . Wasseraufnahme	ISO 10545-3		Ev ≤ 0,5%			Conforme . According to Conforme . Gemäss			
Determinazione della resistenza a flessione e della forza di rottura Flexion and break resistance Résistance à la flexion et à la force de rupture Biegefestigkeit und Bruchlast	ISO 10545-4		Spessore ≥ 7,5 mm	S ≥ 1300 R ≥ 35 N/mm <sup>2</sup>	Conforme . According to Conforme . Gemäss				
Determinazione della resistenza all'abrasione profonda Deep Scratch Resistance Résistance à l'abrasion profonde Tiefenverschleissbeständigkeit	ISO 10545-6		≤ 175 mm <sup>3</sup>		Conforme . According to Conforme . Gemäss	-	Conforme . According to Conforme . Gemäss	Conforme . According to Conforme . Gemäss	
Determinazione della resistenza all'abrasione superficiale PEI Surface abrasion resistance PEI Résistance à l'abrasion superficielle PEI Beständigkeit gegen Abrieb PEI	ISO 10545-7		Classificazione PEI . Classification PEI Classification PEI . Klassifizierung PEI		-	Risultati delle prove disponibili in azienda Test details can be obtained from the company	-	-	
Coefficiente di espansione termica lineare tra 20° e 100° C Linear thermal expansion 20°C to 100°C Dilatation thermique linéaire entre 20°C et 100°C Lineare Waerme-ausdehnung zwischen 20°C und 100°C	ISO 10545-8		Metodo di prova disponibile . Test method available Méthode d'essai disponible . Prüfverfahren verfügbar			Conforme . According to Conforme . Gemäss			
Resistenza agli sbalzi termici . Thermal shock resistance Résistance aux écarts de Température . Temperaturwechselbestaendigkeit	ISO 10545-9		Metodo di prova disponibile . Test method available Méthode d'essai disponible . Prüfverfahren verfügbar			Conforme . According to Conforme . Gemäss			
Resistenza al gelo . Frost resistance Résistance au gel . Frostbeständigkeit	ISO 10545-12		Metodo di prova disponibile . Test method available Méthode d'essai disponible . Prüfverfahren verfügbar			Conforme . According to Conforme . Gemäss			
Reazione al fuoco . Reaction to fire Réaction au feu . Brandverhalten	-		Classe A1 oppure A1fl - Class A1 or A1fl Categorie A1 ou A1fl - Klasse A1oder A1fl			A1-A1fl			
Determinazione della resistenza chimica . Chemical resistance Résistance chimique . Chemikalienbeständigkeit	ISO 10545-13		Classe B mini mo Class B min Clase B Klasse B			A LA HA	A LA -	A LA HA	A LA HA
Determinazione della resistenza alle macchie . Resistance to staining Résistance aux taches . Beständigkeit gegen Fleckenbil	ISO 10545-14		Classe 3 minimo . Class 3 min Clase 3 min . Klasse 3 min			Conforme . According to Conforme . Gemäss			
Resistenza allo scivolamento . Slip resistance Résistance au glissement . Bestimmung der Rutschhemmungsfähigkeit	EN 16165 (previously DIN 51130)		Classificazione R . Classification R Evaluación R . Klassifizierung R			R10	-	R11	R11
Resistenza allo scivolamento - superfici bagnate calpestio a piedi scalzi Bestimmung der Rutschhemmungsfähigkeit - nasse Oberfläche - Barfuß-gehen Coefficient of friction - dry surfaces walking on barefoot	EN 16165 (previously DIN 51097)		Classificazione A B C - Evaluación A B C Klassifizierung A B C - Classification A B C			A+B	-	A+B+C	A+B+C
Resistenza allo scivolamento - coefficiente di attrito dinamico (DCOF) Slip resistance - dynamic friction coefficient Résistance au glissement - resistance de frottement dynamique Bestimmung der Rutschhemmungsfähigkeit - dynamischer reibungskoeffizient	ANSI A326.3		-			≥ 0,42	-	≥ 0,55	≥ 0,55
Coefficiente di attrito dinamico - Resistance de frottement dynamique Dynamischer reibungskoeffizient - Dynamic friction coefficient	METODO B.C.R.A		D.M.I. Giugno 1989 n.236 (μ > 0,40)			Conforme . According to Conforme . Gemäss			

GRADO DI VARIAZIONE CROMATICA Ogni prodotto si caratterizza per un grado di stonalizzazione variabile da prodotto a prodotto, da colore a colore.  
Per stonalizzazione s'intende variazione di gradazione cromatica da piastrella a piastrella.  
COLOUR SHADE VARIATION Every product is characterised by colour-shading that can vary from one product to another and from one colour to another.  
When referring to colour-shading we refer to the chromatic variation of the tile surface.



Prodotto con leggera variazione cromatica  
Product with a slight chromatic variation

# LA CERAMICA. UNA SCELTA SICURA. CERAMICS. A SAFE CHOICE.



**IGIENICA**  
La ceramica è facile da pulire, igienica e pratica; basta un semplice detergente neutro per rimuovere lo sporco e facilmente ritorna alla sua bellezza originaria.

**HYGIENIC**  
Ceramic material is easy to clean, hygienic and practical; all it takes is a simple, neutral detergent to remove dirt and restore it to its original splendour.

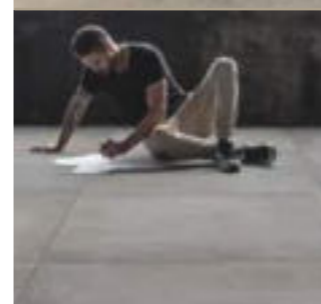

**SALUBRE**  
Grazie alle sue caratteristiche fisiche la ceramica non rilascia alcuna sostanza nociva o VOC (sostanze organiche volatili) nell'ambiente in cui viviamo. Allo stesso modo non emette odori.

**HEALTHY**  
Thanks to its physical characteristics, ceramic material does not release any harmful substances or VOC (volatile organic substances) into the environment we live in, nor does it give off odours.



**RESISTENTE ALL'USURA**  
Il gres porcellanato è un materiale tecnico ultra compatto, altamente resistente all'usura; sopporta bene calpestio, urti, graffi e carichi pesanti.

**WEAR RESISTANT**  
Porcelain stoneware is an ultra-compact technical material, extremely resistant to wear, tread, shock, scratching and heavy loads.



**ANTIMACCHIA**  
La ceramica non teme macchie e non viene danneggiata con l'utilizzo di solventi e detersivi.

**STAIN RESISTANT**  
Ceramic material is resistant to stains and is not damaged by the use of solvents and detergents.

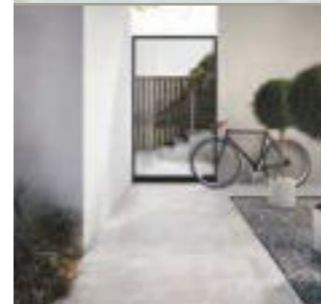

**INGELIVA**  
Il gres porcellanato resiste al gelo e a tutti gli attacchi degli agenti atmosferici, ed è quindi il prodotto ideale anche in ambienti esterni.

**FROSTPROOF**  
Porcelain stoneware is resistant to frost and to all kinds of attack from the elements, making it the ideal product also for outdoors.

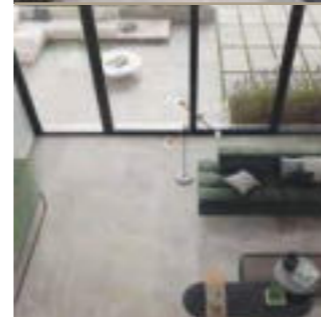

**VERSATILE**  
La ceramica consente tante variazioni di stile e design, grazie all'ampia disponibilità di formati, spessori, finiture e tinte. Inoltre può essere utilizzata in qualsiasi ambiente, sia a pavimento che a rivestimento, in interno o esterno, in ambienti residenziali o pubblici.

**VERSATILE**  
All sorts of style and design variants are possible with ceramics, thanks to the wide availability of different sizes, thicknesses, finishes and colours. It can also be used anywhere, on both floors and walls, indoors or outdoors, in residential or public settings.

Per maggiori informazioni consultare il sito [www.ceramica.info](http://www.ceramica.info) e [www.supergres.com](http://www.supergres.com)  
To find out more, consult the website [www.ceramica.info](http://www.ceramica.info) and [www.supergres.com](http://www.supergres.com)

CERAMICHE  
**SUPERGRES**



# LA CERAMICA. UNA SCELTA SICURA.

## CERAMICS. A SAFE CHOICE.



### IGIENICA HYGIENIC

La ceramica è facile da pulire, igienica e pratica; basta un semplice detergente neutro per rimuovere lo sporco e facilmente ritorna alla sua bellezza originaria. Ceramic material is easy to clean, hygienic and practical; all it takes is a simple, neutral detergent to remove dirt and restore it to its original splendour.



### SALUBRE HEALTHY

Grazie alle sue caratteristiche fisiche la ceramica non rilascia alcuna sostanza nociva o VOC (sostanze organiche volatili) nell'ambiente in cui viviamo. Allo stesso modo non emette odori. Il gres porcellanato è privo di PVC, plastiche o derivati del petrolio.

Thanks to its physical characteristics, ceramic material does not release any harmful substances or VOC (volatile organic substances) into the environment we live in, nor does it give off odours.

Porcelain tiles contain no PVC, plastic or petroleum derivatives.



### RESISTENTE ALL'USURA WEAR RESISTANT

Il gres porcellanato è un materiale tecnico ultra compatto, altamente resistente all'usura; sopporta bene calpestio, urti, graffi e carichi pesanti.

Porcelain stoneware is an ultra-compact technical material, extremely resistant to wear, tread, shock, scratching and heavy loads.



### ANTIMACCHIA STAIN RESISTANT

La ceramica non teme macchie e non viene danneggiata con l'utilizzo di solventi e detersivi.

Ceramic material is resistant to stains and is not damaged by the use of solvents and detergents.



### INGELIVA FROSTPROOF

Il gres porcellanato resiste al gelo e a tutti gli attacchi degli agenti atmosferici, ed è quindi il prodotto ideale anche in ambienti esterni.

Porcelain stoneware is resistant to frost and to all kinds of attack from the elements, making it the ideal product also for outdoors.



### PRODOTTO NEL RISPETTO DELL'AMBIENTE ECO-SUSTAINABLE PRODUCTION

Il processo produttivo aziendale impiega un sistema di raccolta e di riutilizzo degli scarti di produzione, delle acque di lavorazione e del calore generato nelle fasi di produzione. In questo modo si limita il consumo di energia e di materie prime, per un'economia più sostenibile e un ridotto impatto ambientale.

The company's production process uses a system that collects and re-uses production waste, processing water and the heat generated during the production process, thus limiting the consumption of energy and raw materials, for a more sustainable economy and lower environmental impact.



### RESISTENTE AI RAGGI UV: COLORI STABILI NEL TEMPO RESISTANT TO UV RAYS: LASTING COLOUR STABILITY

Esposta al sole anche per lungo tempo la ceramica non cambia colore, e mantiene inalterate nel tempo le sue caratteristiche estetiche e tecniche.

Ceramic material does not fade even after lengthy exposure to sunlight, and maintains its aesthetic and technical characteristics over time.



### PRODOTTO IGNIFUGO FIREPROOF

Resiste al fuoco e non emette fumi in seguito alla combustione.

Resistant to fire and does not emit smoke upon combustion.



### IDEALE PER RISCALDAMENTO A PAVIMENTO IDEAL FOR UNDERFLOOR HEATING

Ottimo conduttore di calore, il gres porcellanato si scalda rapidamente e il calore è rilasciato immediatamente nell'ambiente; in questo modo consente di mantenere limitate temperature d'esercizio dell'impianto di riscaldamento.

An excellent conductor of heat, porcelain stoneware warms up quickly and releases heat into the air immediately, making it possible to keep the heating system working at lower temperatures.



### VERSATILE VERSATILE

La ceramica consente tante variazioni di stile e design, grazie all'ampia disponibilità di formati, spessori, finiture e tinte. Inoltre può essere utilizzata in qualsiasi ambiente, sia a pavimento che a rivestimento, in interno o esterno, in ambienti residenziali o pubblici.

All sorts of style and design variants are possible with ceramics, thanks to the wide availability of different sizes, thicknesses, finishes and colours. It can also be used anywhere, on both floors and walls, indoors or outdoors, in residential or public settings.

**T.20**

Per dettagli sul prodotto in 20 mm di spessore e sui relativi sistemi di posa ed, in particolare, per le raccomandazioni, accorgimenti, limitazioni di utilizzo e precauzioni in fase di posa, si raccomanda di prendere visione dell'ultima versione del catalogo T20 e del sito [www.supergres.com](http://www.supergres.com)

Pour de plus amples détails sur les produits de 20 mm d'épaisseur et sur leurs systèmes de pose, et en particulier, pour les recommandations, mises à jour, limitations d'usage et précautions en phase de pose, veuillez prendre connaissance de la dernière version du catalogue T20 et du site [www.supergres.com](http://www.supergres.com)

Für Details zum Produkt mit 20 mm Stärke und entsprechende Verlegesysteme, insbesondere hinsichtlich Hinweise und Anmerkungen, Nutzungseinschränkungen und Vorsichtsmassnahmen während der Verlegung, wird die Einsicht der letzten Version des Katalogs T20 und der Webseite [www.supergres.com](http://www.supergres.com) empfohlen.

For further details on the 20 mm product and the installation systems, in particular for recommendations, restrictions of use, and precautions during installation, please refer to [www.supergres.com](http://www.supergres.com) and to the latest release of T20 catalogue.

I dati e le informazioni riportate nel presente catalogo sono aggiornate al momento della stampa e potrebbero subire successive correzioni e/o modifiche. Verificare sempre l'ultima edizione disponibile confrontando la data riportata nell'ultima pagina della versione cartacea, con quella indicata nel pdf del catalogo scaricabile dal sito [www.supergres.com](http://www.supergres.com)

I colori e le caratteristiche estetiche dei prodotti sono indicativi e si avvicinano quanto più possibile a quelli reali nei limiti consentiti dai processi di stampa.

Data and information reported in this catalogue are updated at the moment of catalogue printing therefore they may be subject to subsequent corrections and/or amendments. Always check the latest available issue and compare the date reported on the last page of the hard-paper copy of the catalogue with that stated in the pdf. format downloadable on website [www.supergres.com](http://www.supergres.com)

The colours and aesthetic features of products are indicative and reproduce, as close as possible, the real colours and features taking into consideration the restrictions of printing processes.

© Copyright 2023 Ceramiche Supergres Casalgrande (Reggio Emilia) - Italy  
Pubblicato da Ceramiche Supergres. Strada Statale 467, n° 34 - 42013 Casalgrande (RE) Italy - Marzo 2019  
Progetto, direzione e coordinamento a cura dell'ufficio marketing Ceramiche Supergres

© Copyright 2023 by Ceramiche Supergres Casalgrande (Reggio Emilia) - Italy  
Published by Ceramiche Supergres. Strada Statale 467, n° 34 - 42013 Casalgrande (RE) Ital - March 2019  
Project, management and co-ordination by marketing Ceramiche Supergres

CERAMICHE  
**SUPERGRES**

Finito di stampare a Modena (MO) nel mese di Settembre 2023 per conto di Ceramiche Supergres - Strada Statale 467, n° 34 - 42013 Casalgrande (RE) Italy

I prodotti, i marchi e le immagini riprodotte nel presente catalogo sono tutelati ai sensi della normativa vigente in materia di proprietà intellettuale. Ogni violazione degli stessi verrà perseguita a norma di legge.

Printed in Modena (MO) in the month of September 2023 by on behalf of Ceramiche Supergres - Strada Statale 467, n° 34 - 42013 Casalgrande (RE) Italy

All products, trade-marks and photographs reproduced in this catalogue are subject to all existing intellectual property laws. Any breach thereof will be dealt with under the provisions provided by such law.

# Cobb

CERAMICHE  
**SUPERGRES**

Office: Strada Statale 467, 34  
42013 Casalgrande (RE) Italy  
Ph. +39 0522 997411 . Fax Export +39 0522 997415  
Fax Italia +39 0522 997494

Warehouse: Via dell'Industria, 1  
Villaggio Macina - 42013 Salvaterra di Casalgrande (RE) Italy

[info@supergres.com](mailto:info@supergres.com) . [www.supergres.com](http://www.supergres.com)

